

4.0" Midrange

**PURE
SOUND**

Ultra Low Distortion
Midrange



PTT4.0M04-NAC-04 DATA SHEET

KEY SPECIFICATIONS

- ⊙ Dedicated Midrange Driver with Enhanced Efficiency
- ⊙ Negligible Force Factor Modulation
- ⊙ Ultra Low Magnetic Hysteresis Distortion
- ⊙ Utilize PURIFI's Neutral Surround Technology
- ⊙ Designed and Manufactured in Denmark

| | |
|------------------------------|-------------------------|
| Driver size | 4" |
| DC resistance, R_{DC} | 3.4 Ω |
| Resonance freq., f_s | 48 Hz |
| Total Q factor, Q_{ts} | 0.28 |
| Effective piston area | 57 cm ² |
| Equivalent volume, V_{as} | 5.0 L |
| SPL@2.83V _{rms} /1m | 86.1 dB |
| Linear X_{max} | +/- 2.9 mm |
| Mechanical X_{max} | +/- 13.7 mm |
| IEC Power handling | TBD |
| Cone material | Black Anodized Aluminum |

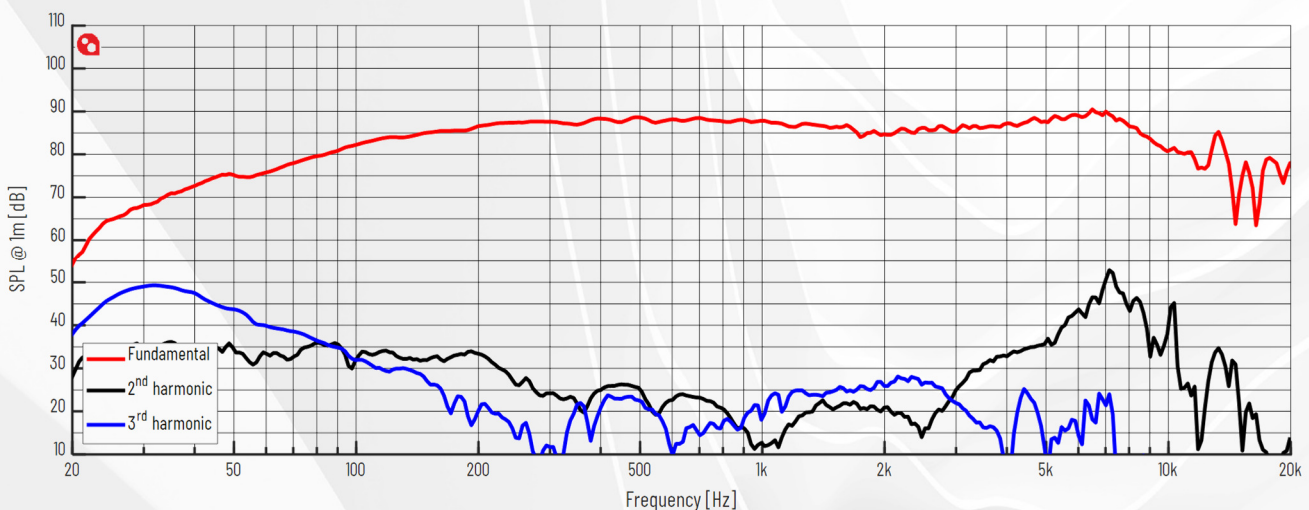

Figure 1 Frequency Response 2.83Vrms @1m

1 Specifications

1.1 Electrical & Acoustical Parameter

| Parameter | | Typ | Unit |
|-----------|---|------|----------|
| Z_n | Nominal impedance | 4 | Ω |
| Z_{min} | Minimum impedance above resonance | 3.7 | Ω |
| f_{min} | Frequency for minimum impedance | 378 | Hz |
| Z_o | Maximum impedance | 51 | Ω |
| R_{DC} | DC resistance | 3.4 | Ω |
| L_e | Voice Coil inductance @ 1kHz 0mm | 0.26 | mH |
| SPL | SPL@2.83V _{rms} /1m, 1000Hz-2800Hz, ref. 20 μ Pa (infinite baffle / 2pi) | 86.1 | dB |
| | SPL@1W(Z_{min})/1m, 1000Hz-2800Hz, ref. 20 μ Pa (infinite baffle / 2pi) | 82.7 | dB |

Table 1 Electrical & Acoustical Parameters

1.2 T/S & Lumped Parameters

| Parameter | | Typ | Unit |
|-----------|---------------------------|------|-----------------|
| f_s | Resonance frequency | 48 | Hz |
| Q_{ms} | Mechanical Q factor | 4.2 | - |
| Q_{es} | Electrical Q factor | 0.30 | - |
| Q_{ts} | Total Q factor | 0.28 | - |
| V_{as} | Equivalent volume | 5.0 | L |
| S_d | Effective piston area | 56.7 | cm ² |
| D | Effective piston diameter | 8.5 | cm |
| Bl | Force factor | 5.9 | N/A |
| R_{ms} | Mechanical resistance | 0.72 | kg/s |
| M_{ms} | Moving mass | 10.1 | g |
| C_{ms} | Suspension compliance | 1.09 | mm/N |

Table 2 T/S & Lumped Parameters

1.3 Mechanical Properties

| Parameter | | Typ | Unit |
|------------------------------|--|---------|------|
| Excursion Properties | | | |
| X_{max} | Linear excursion = (Voice Coil length - Airgap height) / 2 | +/-2.9 | mm |
| | Mechanical excursion | +/-13.7 | mm |
| Physical Dimensions | | | |
| | Basket diameter | 125 | mm |
| | Cutout diameter | 101 | mm |
| | Mounting hole pattern diameter | 115 | mm |
| | Mounting hole diameter | 4.2 | mm |
| | Magnet diameter | 90 | mm |
| | Outer flange height | 3.2 | mm |
| | Build-in depth | 73.5 | mm |
| | Weight | 1.25 | kg |
| Voice Coil Properties | | | |
| | Voice Coil diameter | 30 | mm |
| | Voice Coil length | 9.9 | mm |
| | Voice Coil layers | 4 | - |
| | Airgap height | 4 | mm |
| | Winding material | CCAW | - |

Table 3 Mechanical Properties

1.4 Power Handling

| Parameter | | Typ | Unit |
|-----------|---|-----|------|
| | Long term maximum power (IEC268-5 18.2) | TBD | W |
| | Rated noise power, 100h (IEC268-5 18.4) | TBD | W |

Table 4 Power Handling

1.5 Typical Performance, Graphs

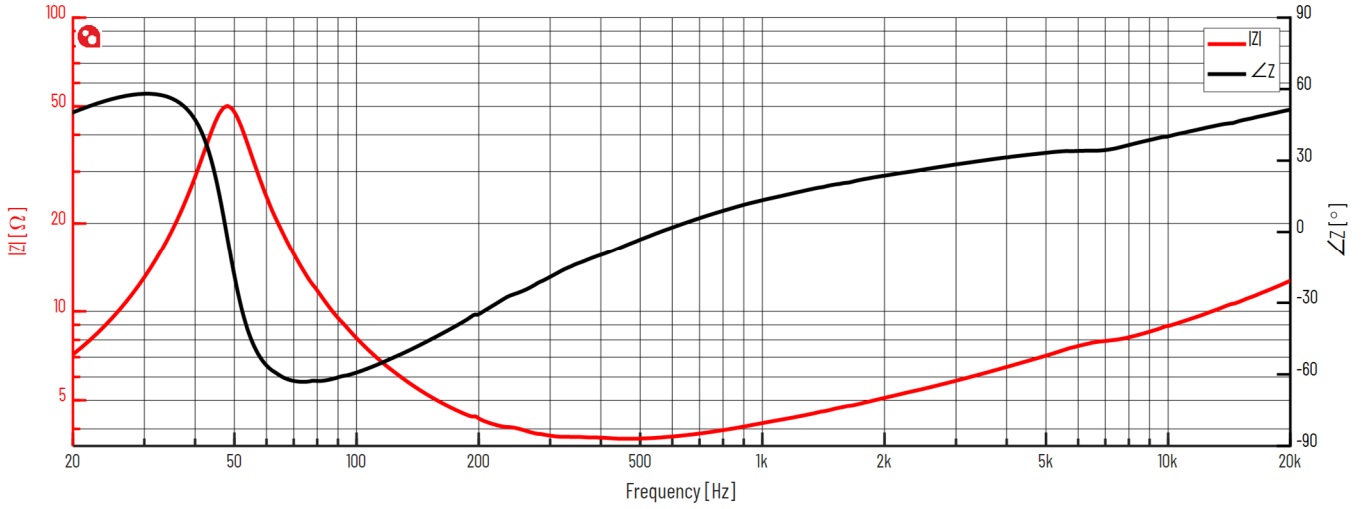

Figure 2 Impedance Response @ 2.83V

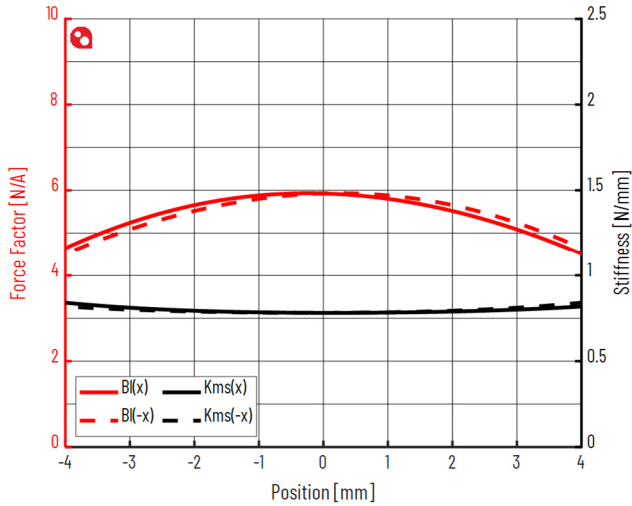

Figure 3 Force Factor and Stiffness vs Voice Coil Position

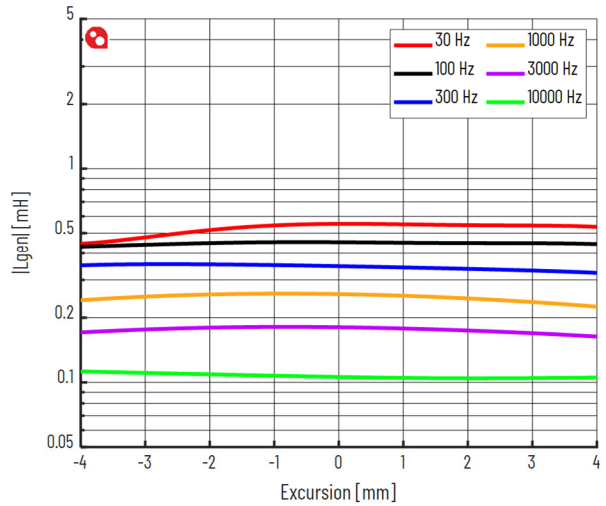

Figure 4 Inductance vs Voice Coil Position

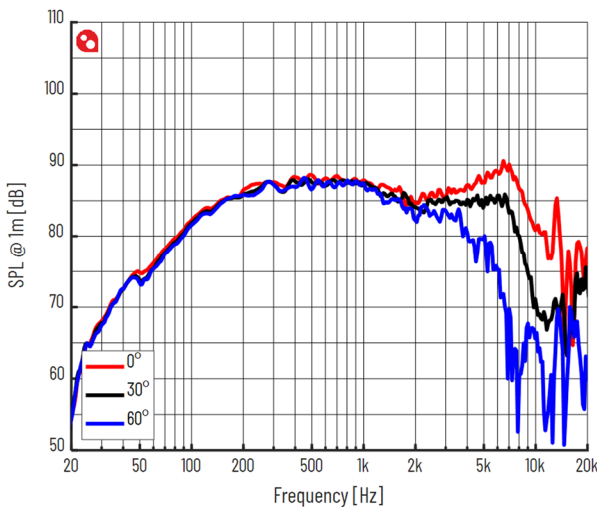

Figure 5 Axial Frequency Response @ 1m, 2.83Vrms

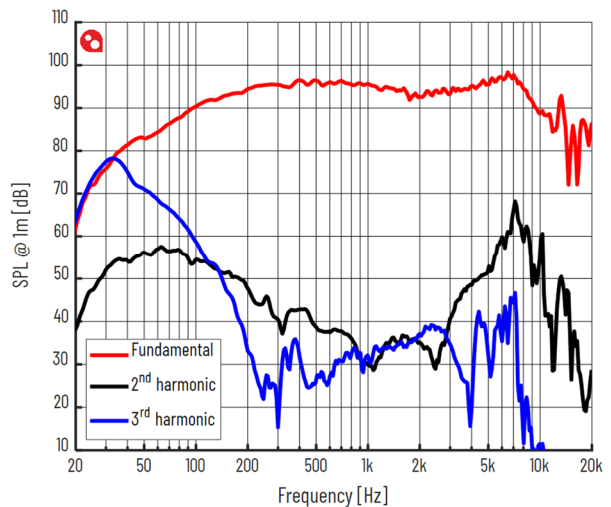

Figure 6 Frequency Response @ 1m, 94dB

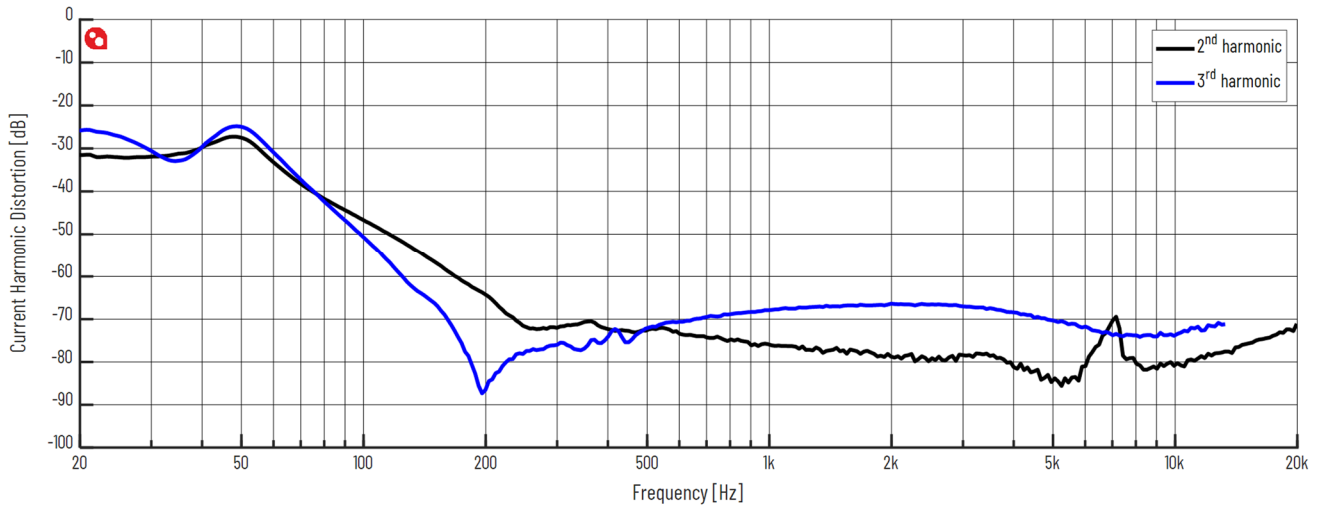

Figure 7 Current Harmonic Distortion @ 2.83Vrms

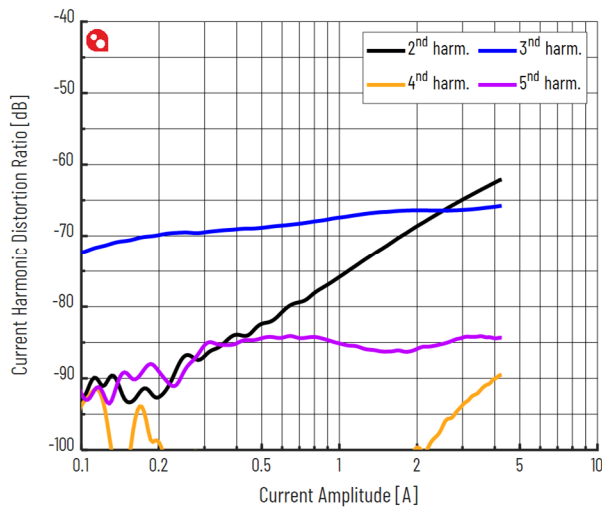

Figure 8 Current Harmonic Distortion @ 1kHz, 0-14.1Vrms

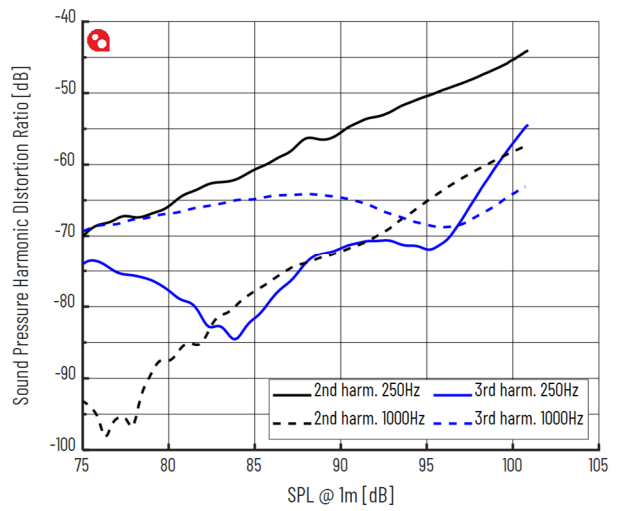

Figure 9 Sound Pressure Harmonic Distortion @ 1m, 0-14.1Vrms

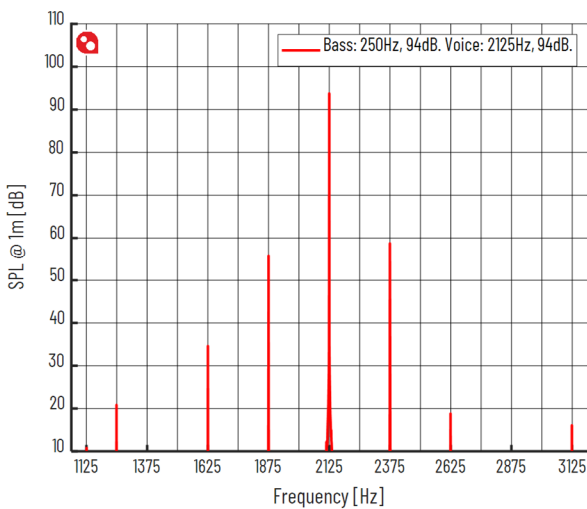

Figure 10 Intermodulation Distortion @ 250Hz 94dB, 2125Hz 94dB

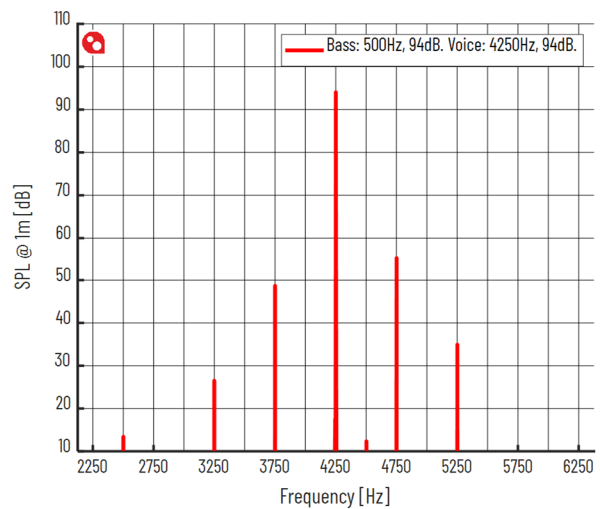
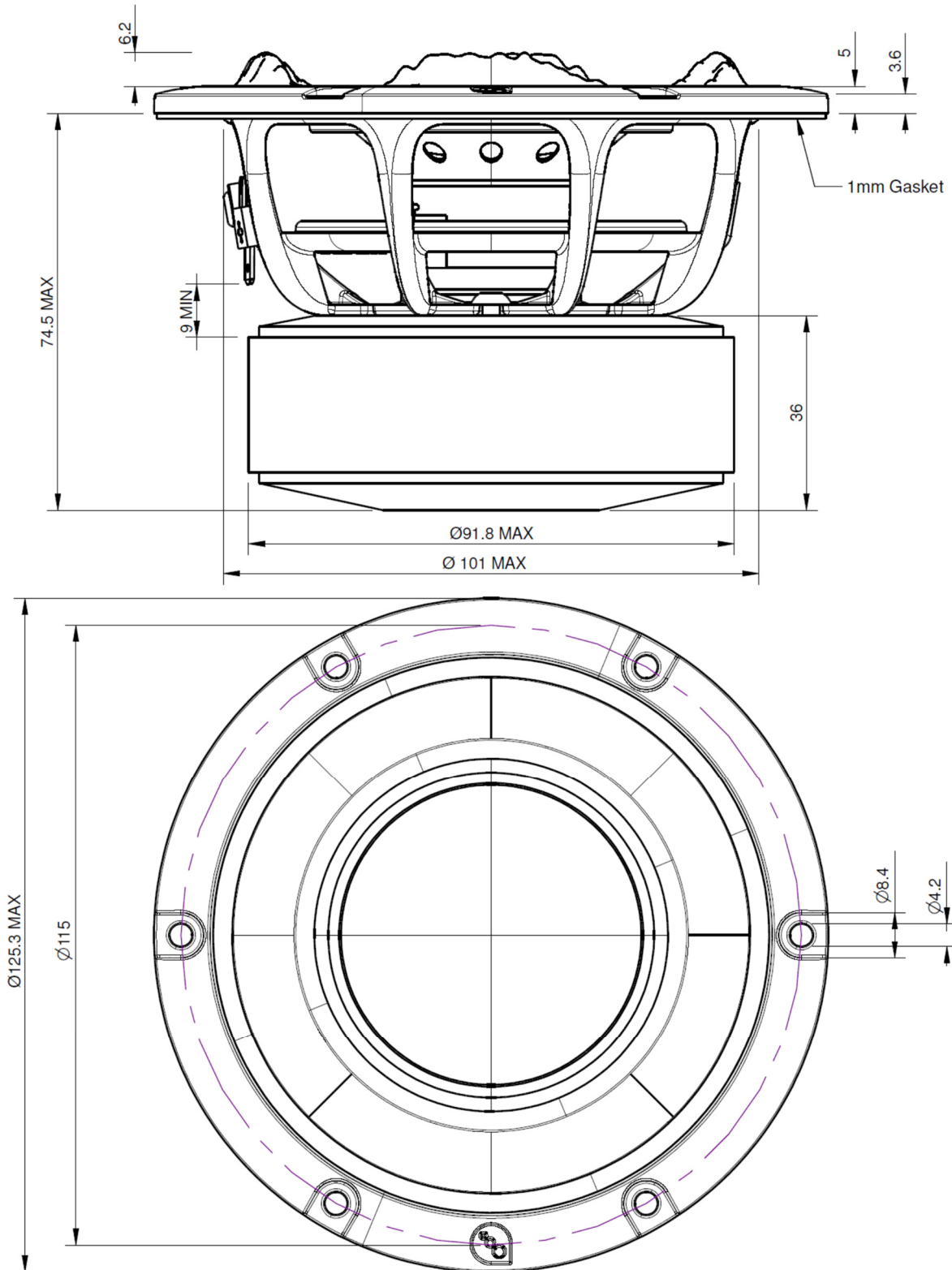

Figure 11 Intermodulation Distortion @ 500Hz 94dB, 4205Hz 94dB

2 Drawings



Accuracy of Information: To the extent PURIFI ApS provides information on function and specifications, PURIFI ApS attempts to be as accurate as possible. However, PURIFI ApS does not warrant the accuracy of information on its website and other documents as accurate, complete, reliable, current, or error-free. All data and information in the Data Sheet are subject to change.